

Esparto Community Service District
Dedicated to Safe Water and Responsible Waste Management

P.O. Box 349, 26490 Woodland Ave, Esparto, CA 95627
Phone: 530-787-4502 Fax: 530-787-4219
E-mail: ecsd_16960@sbcglobal.net

ESPARTO CSD

CONSTRUCTION STANDARDS

CRITERIA FOR DESIGN OF IMPROVEMENTS
ESPARTO COMMUNITY SERVICES DISTRICT
IMPROVEMENT STANDARDS

Adopted
Resolution 06-05

Esparto Community Services District
16960 Yolo Avenue
Esparto, California 95627

**ESPARTO COMMUNITY SERVICES DISTRICT
IMPROVEMENT STANDARDS**

<u>INDEX</u>	<u>PAGE</u>
Part A <u>Criteria for Design of District Improvements</u>	
General	1.
Section I	
Sanitary Sewers	
1. Hydrology – Design Criteria	4
2. Hydraulics	5
3. Structures	6
4. Materials	6
5. Trench Bedding and Backfill	6
6. House Laterals	6
7. Testing and Flushing	7
8. Televised Inspection	7
Section II	
Water Systems	
1. Design	7
2. Materials	8
3. Fire Hydrants	9
4. Services	9
5. Backflow Prevention Devices	9
6. Pressure Testing	9
7. Disinfection	10
Section III	
Fee Schedule	
Plans and Specifications checking fees	10

Construction Inspection Fees.....11

Section IV

Final Maps and As Builts

Final Maps.....11
As Built Plans.....11

Part B

Check list.....13

Part C Standard Details

Section I

Design Details

No. 1 - Thrust Blocks.....14
No. 2 - Typical Blow-off Installation.....15
No. 3 - House Water Services.....16
No. 4 - House Water Services.....17
No. 5 - Standard Sanitary Sewer Manhole.....18
No. 6 - Standard Sanitary Sewer Manhole Drop Inlet.....19
No. 7 - Standard Sanitary Sewer Manhole Lid.....20
No. 8 - Gate Valve Box.....21
No. 9 - Approved Air Valve Installation.....22
No.10 - Lateral Cleanout Assembly.....23
No.11 - Sewer House Lateral.....24
No.12 - Backfill and Trench Restoration.....25
No.13 - Trust Blocks.....27
No.14 - Manhole Drop Connection.....28
No.15 - Main Cleanout Assembly.....29
No.16 - Fire Hydrant Normal Installation.....30
No.17 - Fire Hydrant Short Side Installation.....31
No.18 - Large Fire Service Connection.....32
No.19 - Bedding, Backfill and Trench Restoration.....33

CRITERIA FOR DESIGN OF IMPROVEMENTS

GENERAL:

These instructions have been prepared for the use of the designer of public improvements within the Esparto Community Services District, Yolo County, California. The purpose is to encourage uniformity of design criteria and to aid in the preparation of plans and specifications.

The designer is reminded that in addition to the standards and criteria contained herein it will be necessary to conform to all applicable State and Federal Codes.

SECTION I

SANITARY SEWERS

1. HYDROLOGY – DESIGN CRITERIA

These Improvement Standards shall only apply to sewer collection facilities to be maintained by the Esparto Community Services District. These Standards are minimum design criteria. The installation of sewer mains shall be The ECSD General Manager or the appointed designee may permit

modifications or may require higher standards where unusual conditions are encountered.

A. Flow Determination

Flow determination shall be based upon the approved zoning, existing land uses or General Plan land use designations, whichever produces the greatest flow. The minimum population density used shall be based on the latest US Census Tract data for single-family residential housing. Design flows shall be calculated using the following data:

Land Use	Unit	Minimum Average Daily Flow	Peaking Factor
		Gallons per Unit	
Single Family Residential (3.5 persons per unit)	Residence	350	3
Multi-Family Residential (3.0 persons per unit)	Residence	300	3
Commercial, Office	Gross Acre*	2,500*	2-4*
Central Business District	Gross Acre*	3,500	2-4*
Light Industrial	Gross Acre*	2,000*	2-4*
Heavy Industrial	Gross Acre*	3,000-5,000*	2-4*
Recreation and Parks	Gross Acre	200	2
Elementary School	Student	50	3
Middle School	Student	50	3
High School	Student	60	3
* Subject to review and confirmation of intended uses and waste generation rates. Industrial uses may require private pre-treatment and/or peak reduction facilities. Peaking Factors may be increased or decreased based on flow peaking studies for trunk lines and pumping stations.			

2. HYDRAULICS:

The minimum main line size shall be 6 inches in diameter. The sewer shall be designed to flow ½ full with a velocity of two to ten (fps) feet per second. Minimum slopes shall be as follows:

6" – 0.005 ft / ft, 8" – 0.0035 ft / ft, 10" – 0.0025 ft / ft,

12" – 0.002 ft / ft, 15" – 0.0015 ft / ft, 18" – 0.001 ft / ft.

Sanitary sewers shall have 3' minimum cover unless ductile iron water pipe is utilized.

Sanitary sewer house laterals shall have 3' minimum cover at the curb line unless cast iron soil pipe is utilized.

3. **STRUCTURES:**

Manholes shall be placed at intervals not greater 400 feet and at changes in grade, elevation, direction and size. The sanitary sewer line shall be located in the street as shown on the standard-typical street section, and in no case shall the sewer and water mains be any closer than 10 feet apart. When sewer and water mains cross they shall be such that the water line is the highest and shall have a minimum of 1 foot clearance between them. Clean outs shall be located at the ends of all sewer lines except when it is a collector manhole for sewer laterals in subdivision cul de sacs.

4. **MATERIALS:**

Sanitary sewers shall be constructed with Extra Strength Vitrified Clay pipe conforming to ASTM standard specification designation C-700-86.

The V.C. pipe joints shall be of the compression type conforming to ASTM designation C-425-86 such as "Wedgelock", "Speedseal"; or approved equal.

5. **TRENCH BEDDING AND BACKFILL:**

Sanitary sewer pipes shall be bedded in a minimum of four (4) inches of angular or crushed material conforming to size #67, ASTM D-448. Backfill shall be sand to a height six (6) inches above the top of the pipe or main, except as noted on the details.

Bell holes shall be dug at each joint. Trench width shall be the outside diameter of the pipe plus Twelve (12) inches. Sanitary sewer pipes and trenches under streets, curbs and gutters, sidewalks or driveways shall be backfilled from the bottom up to subgrade plane to 95% relative compaction.

6. HOUSE LATERALS:

The location of all sewer laterals shall be marked on the curb by scribing to a minimum depth of ¼" the letter "S" it shall also be a maximum width and height of 2 inches and placed with an approved scribing tool.

7. TESTING AND FLUSHING:

All sanitary sewers and house laterals shall be air tested in accordance with ASTM C-828-90 low pressure Air Test. Procedures are to add pressure to until the internal air pressure is raised to 4.0 psi then allow 5 minutes for pressure to stabilize. Then drop pressure to 3.5 psi and hold not dropping any more than 1psi for the required time in the tables contained in the ASTM C-828-90.

All sewers shall be balled and flushed prior to acceptance of the sewer line.

8. TELEVISED INSPECTION:

All Completed sewer lines shall be televised before acceptance of the sewer line. Prior to Televising the sewers shall have a minimum of 1000 gallons of water per 500 ft of sewer lines sized 6", 1200 gallons of water per 500 ft of 8", 1500 gallons of water per 500 ft of 10", and so on shall be released in up stream manhole within 24 hours of televising.

All video tapes or CDs shall become the property of the District.

SECTION II

WATER SYSTEM

1. **DESIGN:**

The system shall be designed to form a grid of mains and feeders cross connecting and looping wherever possible. Lines shall be of sufficient size, considering length and character of the area served to deliver adequate fire and domestic consumption flows. Normal operating pressure at the service connection shall not be less than 35 psig nor more than 65 psig.

Minimum pipe size shall be eight inches in diameter unless the feeder is very short and a six inch diameter is allowed if approved by the General Manager of the District. An eight inch pipe shall be limited to a length 1000 feet unless looped

In commercial or industrial, the minimum size of the water main shall be ten inches in diameter and interconnected within every 600 feet, unless calculations indicate a larger size. The distribution system shall be valved so that areas may be conveniently shut down for breakage or repairs and never have more than one fire hydrant out of service at once.

When lines are not looped and a fire hydrant is not provided at the terminus of a line, a blow off shall be provided.

Thrust blocks and/or retainer glands shall be designed and provided at all changes in direction. Minimum cover over the line is 36 inches over the top of pipe under sidewalks and street improvements.

All services shall be metered in cubic feet.

Water lines shall be laid at least 10 feet horizontally from and at a higher elevation than sanitary sewers, preferably 1.0 foot separation.

2. **MATERIALS:**

Water mains shall be new ductile iron pipe Class 50 ANSI / AWWA C151 / A21.51

"Tyton" joints or equal and cement mortar lining as per ANSI A21.4 – 1974 or latest standard. Service taps may be direct tap with waterworks CC or AWWA threads or saddled.

All ductile iron fittings shall be mechanical joint.

All ductile iron pipe and fittings shall be encased with polyethylene film conforming to ASTM Standard Specification D – 1248 – 68 and ANSI A21.5 – 1972 or latest standard.

3. FIRE HYDRANTS:

Maximum spacing shall be 500 feet – residential, 300 feet – commercial and industrial.

Minimum size of fire hydrant lateral service is 6 inches.

All placements of fire hydrants shall be subject to the approval of the Fire Department.

Specifications for hydrants are set forth in the accompanying standard drawing details.

4. SERVICES:

All services shall be extra strength 200 psi test, copper tubing size Polyethylene, with Mueller or equal brass connections and stainless steel inserts as shown on the metered service detail. Meter Boxes shall be Christy or equal either concrete with diamond plate lids in traffic areas or fiberlyte in lawn or landscaped areas. Meter box lids shall be drilled to accommodate Touch pad / MXU transceiver.

All services shall be 1 ½ inch or larger for fire sprinklers and shall include a tee for ¾ or 1 inch metered domestic service to the residence as shown on the metered service detail.

All water services shall be marked on the curb by scribing to a minimum depth of ¼" the letter "W" it shall also be a maximum width and height of 2 inches and placed with an approved scribing tool

5. BACKFLOW PREVENTION DEVICES:

An approved backflow prevention device shall be installed when there is a potential cross connection with District Water, as defined by the Districts General Manager in accordance with the Health Code of the State of California and the Districts Cross Connection Ordinance.

6. TESTING:

A leakage test of 150 psi for two hours shall be required including services unless directed otherwise by the Inspector or the District General Manager.

The allowable leakage shall not exceed the values given below for each 1,000 feet of line:

6 inch – 0.55 gallons / hour

8 inch – 0.74 gallons / hour

10 inch – 0.92 gallons / hour

12 inch – 1.10 gallons / hour

14 inch – 1.29 gallons / hour

16 inch – 1.47 gallons / hour

18 inch – 1.66 gallons / hour

20 inch – 1.84 gallons /hour

7. DISINFECTION:

All pipe, before being placed in service, shall adhere to the following:

- A. Be disinfected according to AWWA Standard Specifications.**
- B. Be flushed until Chlorine residual is at District Water line Background levels.**
- C. Be sampled for Coliform Bacteria with a District Representative signature on the Chain of Custody and the District has a copy of the results.**

SECTION III

FEE SCHEDULE

1. PLAN AND SPECIFICATION CHECKING FEES:

Fees for checking construction plans and specifications shall be one percent (1%) of the estimated construction cost of all water and sewer facilities including sewage treatment and water production facilities and controls. Fees shall be paid at the same time the plan are submitted to the District for checking, based upon the estimated cost of facilities and later adjusted to actual construction costs.

2. CONSTRUCTION INSPECTION:

Fees shall be paid to the District based upon the following schedule and the estimated cost of construction of all water and sewer facilities including treatment systems and water production facilities.

Fee Schedule – Four percent (4%) up to \$10,000.

Three percent (3%) from \$10,001. to \$50,000.

One percent (1%) from \$50,000. and over.

Fees shall be paid at the time the final map is presented to The District for its acceptance, or prior to the commencement of construction of the subdivision improvements, which ever comes first, and later adjusted to the actual construction cost.

SECTION IV

FINAL MAPS & AS BUILTS

1. FINAL MAPS:

Two (2) copies of the final approved plans shall be submitted to the District before commencement of construction on any water and sewer facilities in the subdivision.

2. AS BUILT PLANS

Two (2) copies of as built plans shall be submitted to the District before the District will give its final approval of the water and sewer utilities.

CHECK LISTS

PART B

SUBDIVISION PRILIMINARY MAP

OR

PARCEL MAP – PRELIMINARY

Check List

_____ **Location of the proposed subdivisions with reference to section, township,
range and streets which bound the property.**

_____ **Total area of proposed subdivision.**

_____ **Topography and lot patterns proposed.**

_____ **Proposed utilities - gas, electric, water, sewer and fire protection**

_____ **Other features required to adequately represent a comprehensive
development plan.**

PART C
STANDARD DETAILS

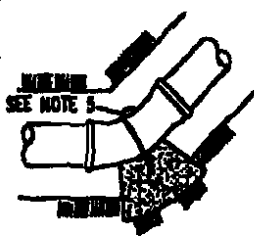
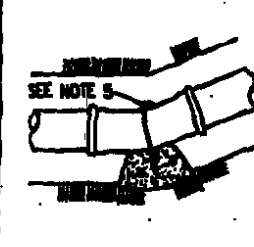
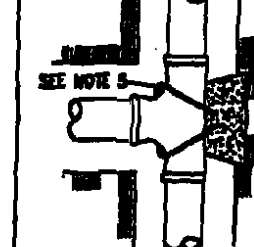
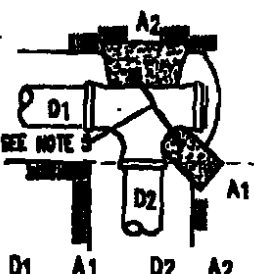
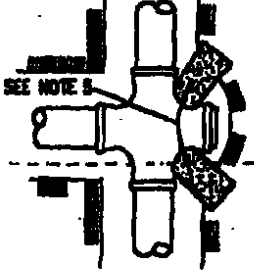
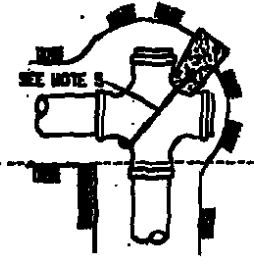
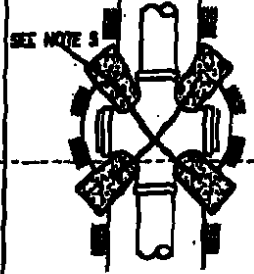
TYPE OF FITTING		90° BEND	45° BEND	11 1/2° OR 22 1/2° BEND	TEE OR DEAD END
TYPICAL INSTALLATION					
SIZE OF PIPE	4"	2	1	1	2
	6"	4	2	1	3
	8"	7	4	2	5
	10"	12	6	3	8
	12"	16	10	5	12
	24"	60	30	16	40
	30"	80	45	25	60
TYPE OF FITTING		TEE WITH PLUG	CROSS WITH PLUG	CROSS WITH PLUGS	CROSS WITH PLUGS
TYPICAL INSTALLATION					
SIZE OF PIPE	4"	4" 2	4" 2	2	2
	6"	6" 4	6" 3	4	4
	8"	8" 6	8" 5	7	7
	10"	10" 10	10" 6	12	12
	12"	12" 14	12" 12	16	16
	24"	24" 55	24" 40	40	40
	30"	30" 80	30" 60	60	60

NOTES:

REQUIRED BEARING ~ TOTAL SQUARE FEET

1. THRUST BLOCKS TO BE CONSTRUCTED OF CLASS "B" CONCRETE.
2. AREAS GIVEN ARE FOR CLASS 150 PIPE AT TEST PRESSURE OF 150 P.S.I. IN SOIL WITH 2,500 P.S.F. BEARING CAPACITY. INSTALLATIONS USING DIFFERENT PIPE, TEST PRESSURES, AND/OR SOIL TYPES SHOULD ADJUST AREAS ACCORDINGLY; SUBJECT TO APPROVAL BY CITY ENGINEER.
3. THRUST BLOCKS TO BE POURED AGAINST UNDISTURBED SOIL.
4. JOINTS TO BE KEPT CLEAR OF CONCRETE.
5. NUMBER 4 REBAR SHALL BE PLACED OVER PIPE AND EMBEDDED IN CONCRETE WHEN PIPE DIA. IS 10" OR LESS.
6. THRUST BLOCKS TO BE IN PLACE 7 (SEVEN) DAYS BEFORE TESTING.
7. ALL PLUGS SHALL BE SECURED WITH THRUST BLOCKS.
8. RETAINER GLANDS (BAA IRON, SERIES 100 OR EQUAL) MAY BE USED WITH JOINT FITTINGS IN LIEU OF THRUST BLOCKS WHERE THRUST BLOCKS ARE NOT FEASIBLE.

**ESPARTO COMMUNITY SERVICES DISTRICT
WATER AND SEWER PLACEMENT IN STREET RIGHT-OF-WAY**

DETAIL #1

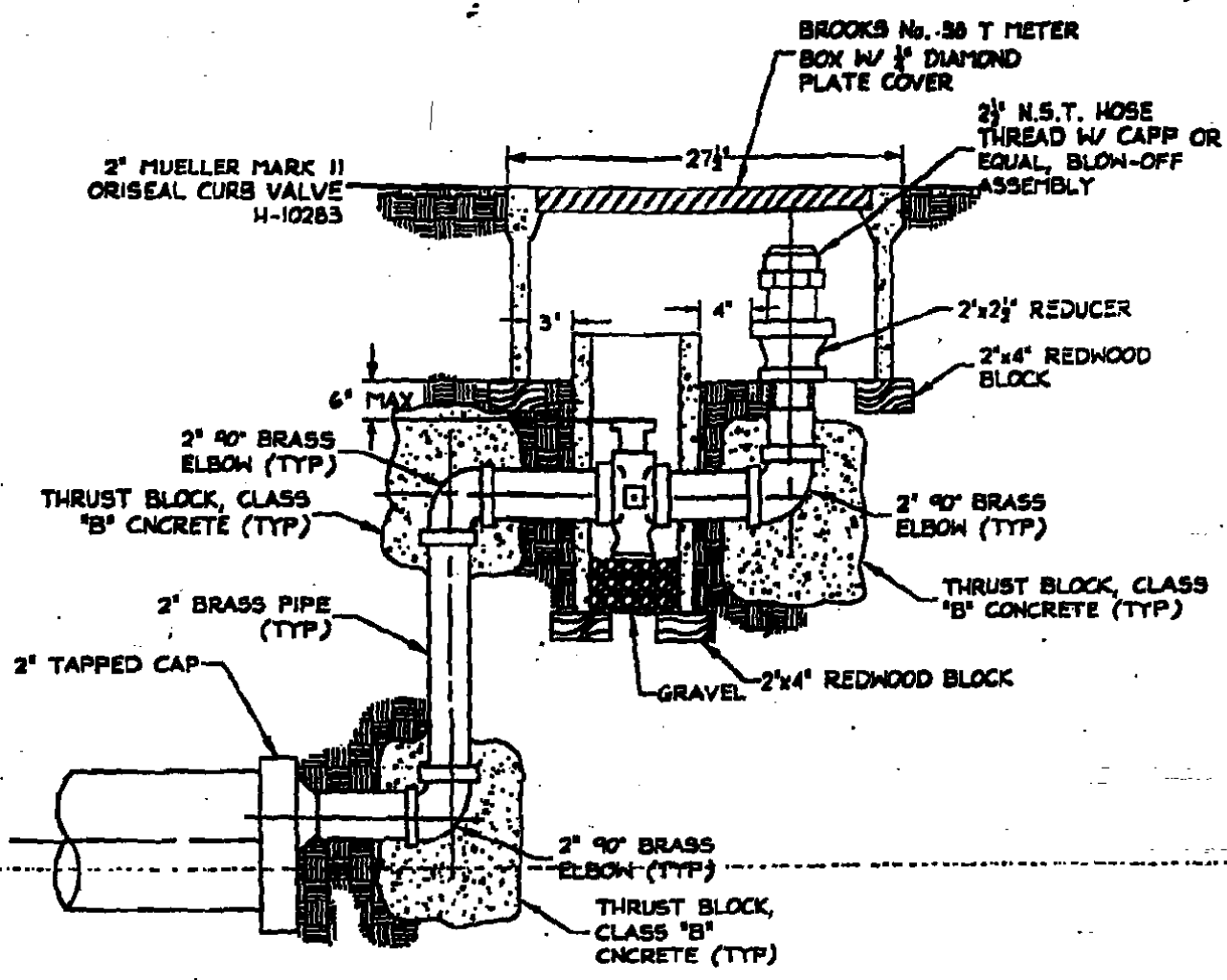

Typical Blow-Off Installation
ESPARTO COMMUNITY SERVICES DISTRICT
DETAIL # 2

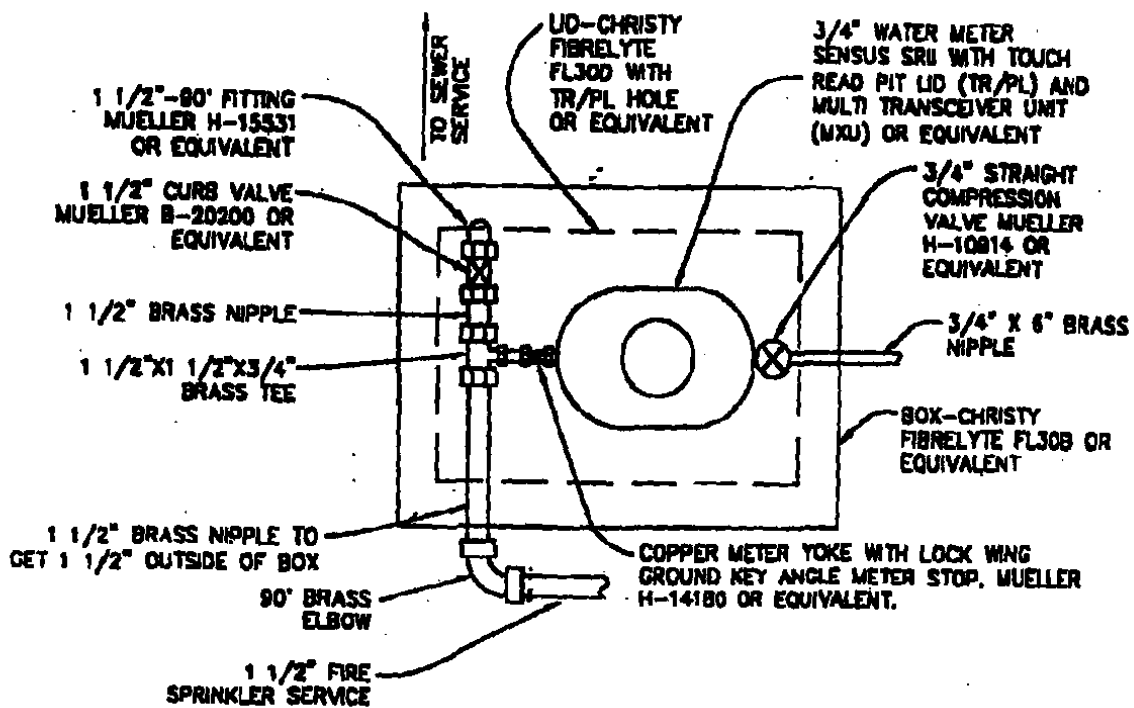

PLAN VIEW 3/4" DOMESTIC WATER SERVICE
AND 1 1/2" FIRE SPRINKLER SERVICE

11

NTS

**Plan View 3/4" Domestic Water Meter, Box Assembly and
1 1/2" Fire Sprinkler Service With-In Meter Box Assembly**

ESPARTO COMMUNITY SERVICES DISTRICT

DETAIL # 3

TECHNICAL A-1024 FRAME & COVER
OR EQUAL W/ "SEWER" ON COVER.

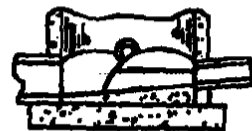
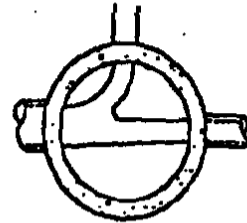
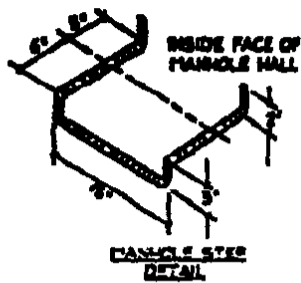

JUNCTION P.I.P. BETWEEN
DIFFERENT PIPE SIZES

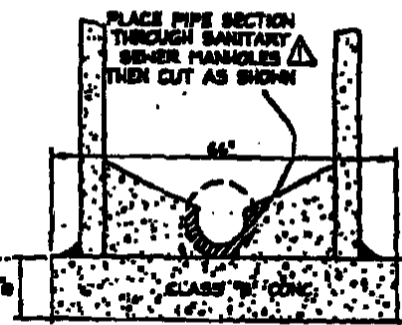

SHAPING BOTTOM OF MANHOLE

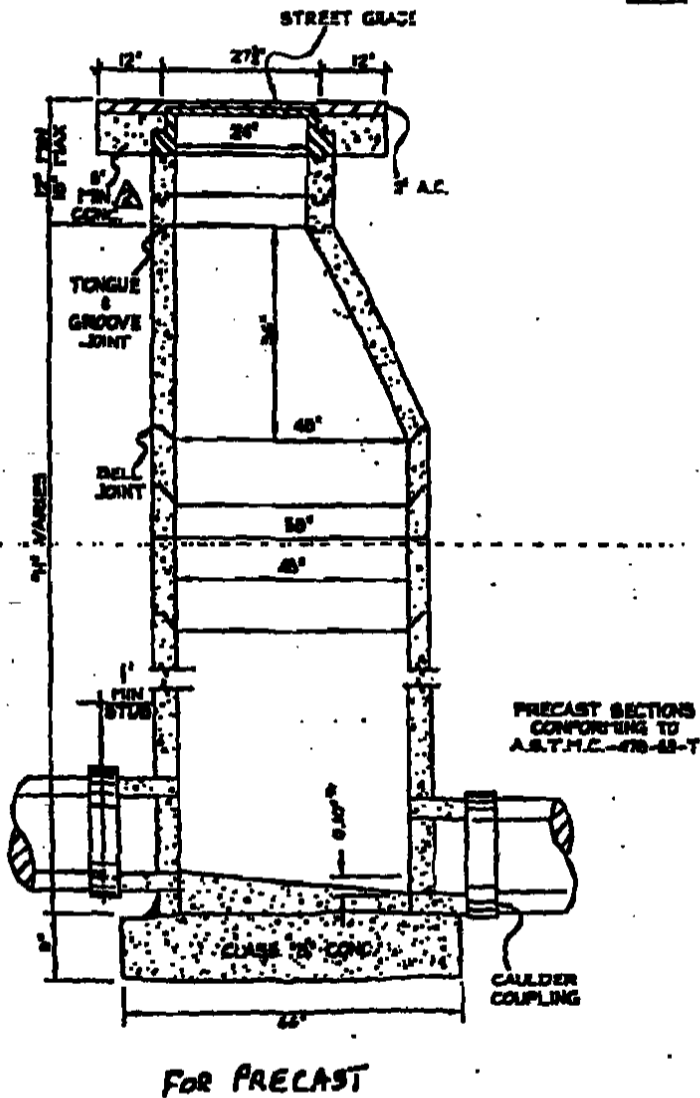

NOTES

1. STEPS SHALL BE PLACED IN MANHOLES OVER 8' HIGH, PLACE STEPS AT 16" INTERVALS.
2. STEPS SHALL BE FABRICATED OF 1/2" FIBERGLASS OR EQUAL.
3. PLACE PIPE AND FITTINGS THROUGH MANHOLE.
4. TO FORM CHANNEL IN MANHOLE, REMOVE TOP OF PIPE AND FITTING.
5. 0.10' DROP NOT REQUIRED UNLESS INDICATED ON PROFILE.

**Sanitary Sewer Manhole
ESPARTO COMMUNITY SERVICES DISTRICT**

DETAIL # 5

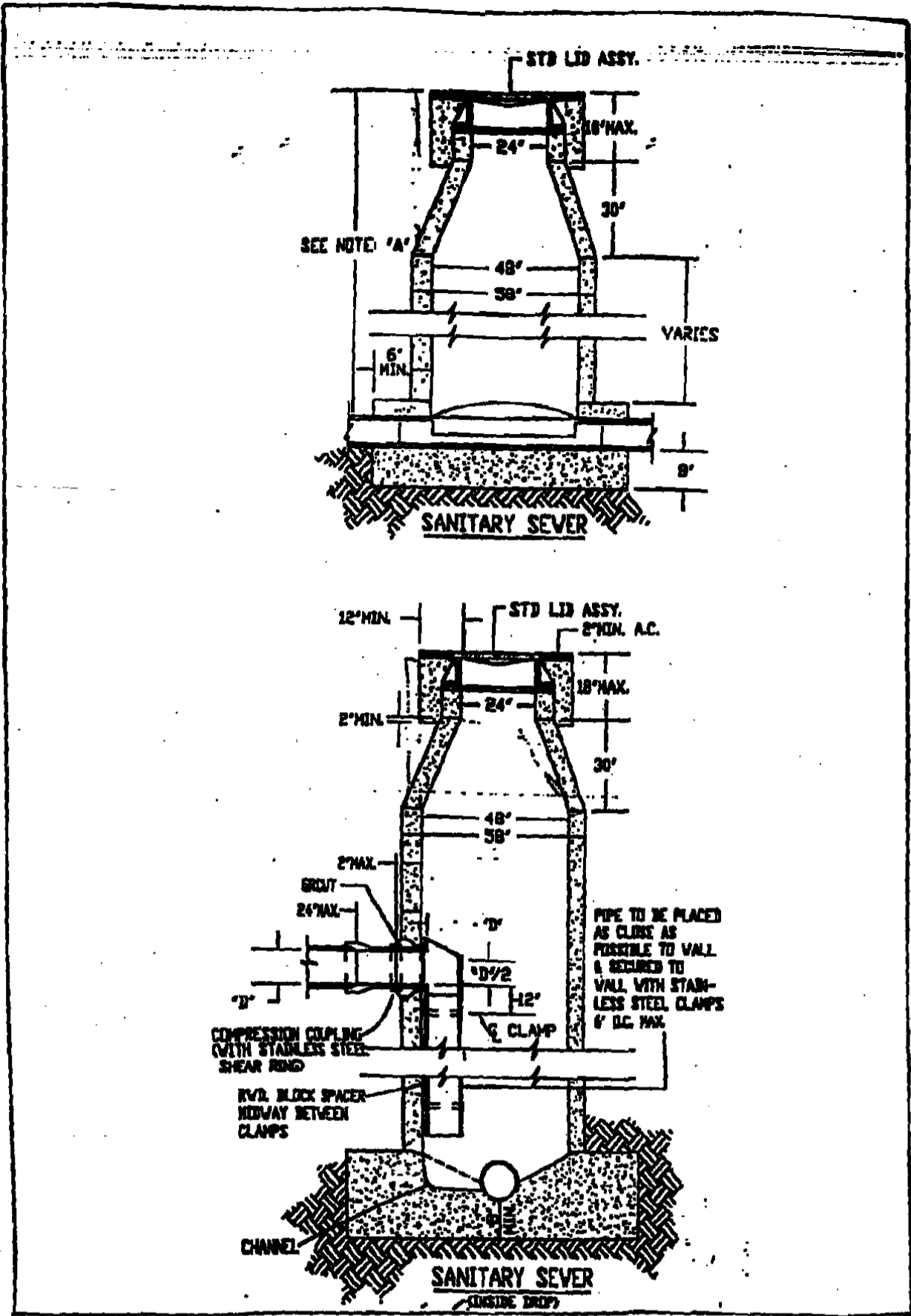

Sanitary Sewer Manhole with drop Inlet
ESPARTO COMMUNITY SERVICES DISTRICT

DETAIL # 6

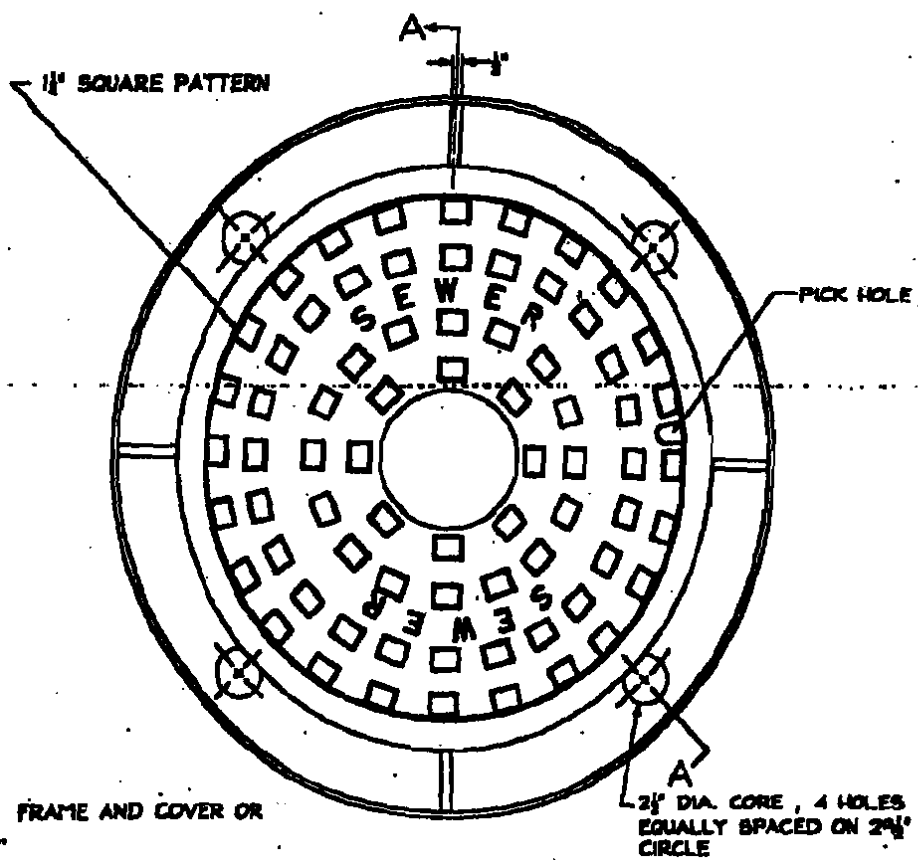
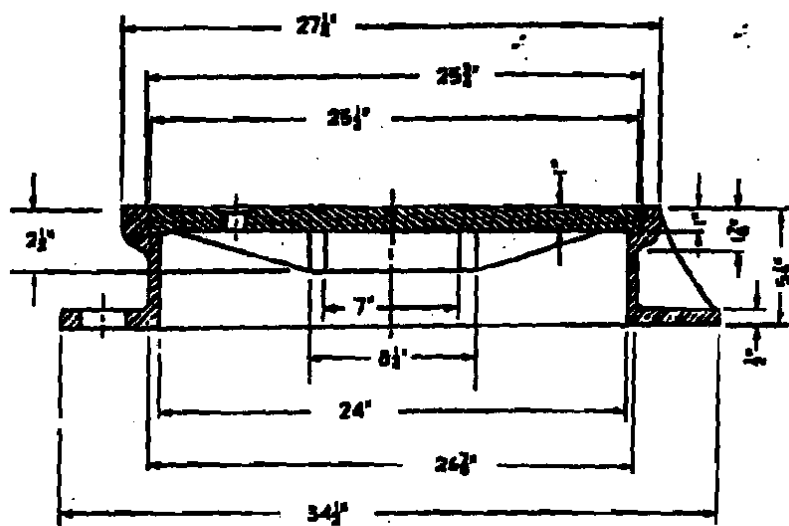

NOTES: TEICHERT A-1024 FRAME AND COVER OR APPROVED EQUAL.

MARK "SEWER" ON COVER FOR SANITARY SEWER MAN HOLE.

MARK "STORM DRAIN" ON COVER FOR STORM DRAIN MAN HOLE.

2 1/2" DIA. CORE, 4 HOLES EQUALLY SPACED ON 2 1/2" CIRCLE

**Sanitary Sewer Cover Assembly
 ESPARTO COMMUNITY SERVICES DISTRICT
 DETAIL # 7**

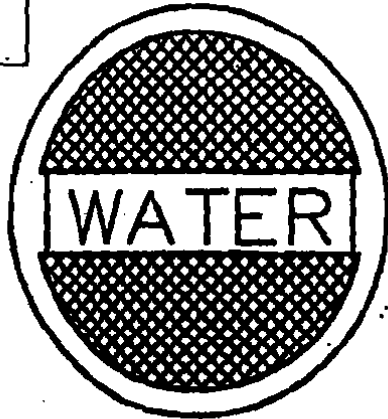
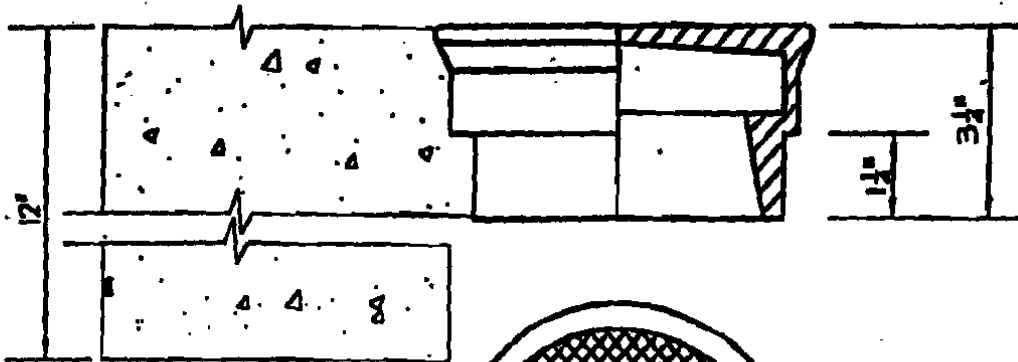

CHRISTY G5 TRAFFIC
BOX & LID G5C

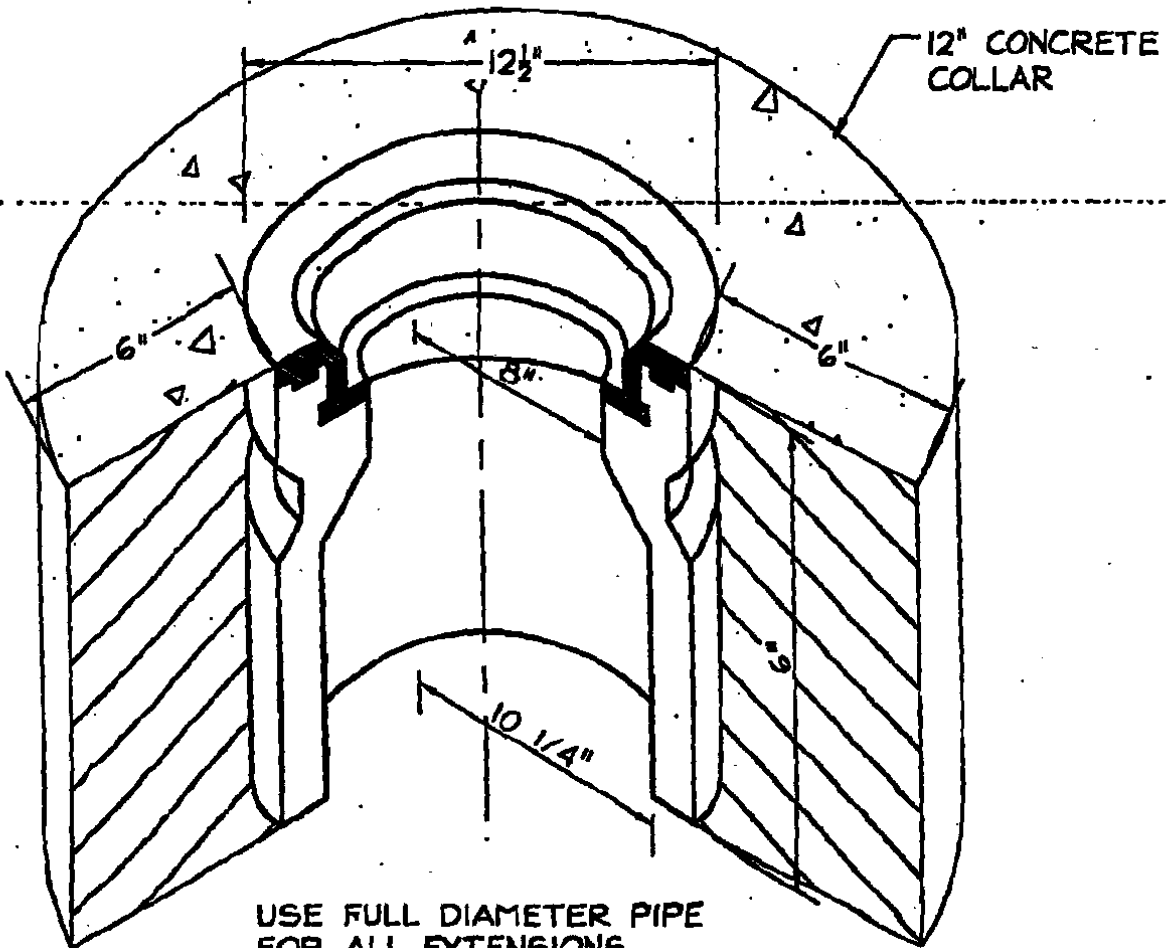

USE FULL DIAMETER PIPE
FOR ALL EXTENSIONS

Water Valve Box and Lid

ESPARTO COMMUNITY SERVICES DISTRICT

DETAIL # 8

① SERVICE SADDLE

② CORP STOP

③ 90° ELBOW, BRASS

④ NIPPLE, BRASS

⑤ RIGID PIPE, BRASS

⑥ UNION, BRASS

⑦ AIR VACUUM AND AIR RELEASE VALVE

⑧ 90° ST. ELBOW

⑨ VAULT 17 1/4" x 30" CHRISTY B-36 WITH LID AND EXTENSIONS AS NECESSARY

⑩ DRAIN ROCK

⑪ SCREEN FILTER

⑫ GATE VALVE

⑬ VALVE AND PIPEING TO BE LOCATED AWAY FROM TRAFFIC

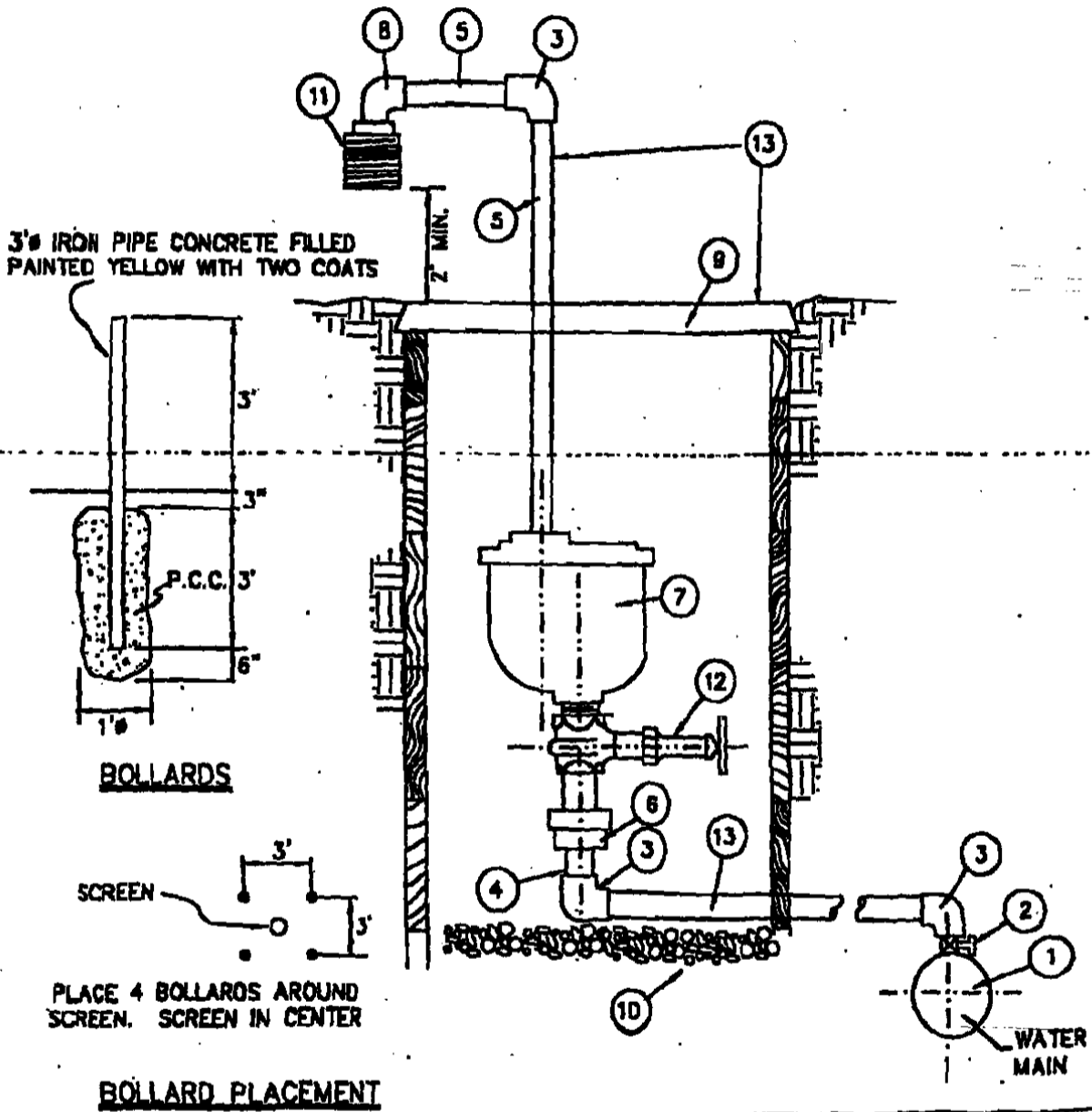

**Approved Air Relief Valve Installation
ESPARTO COMMUNITY SERVICES DISTRICT**

DETAIL # 9

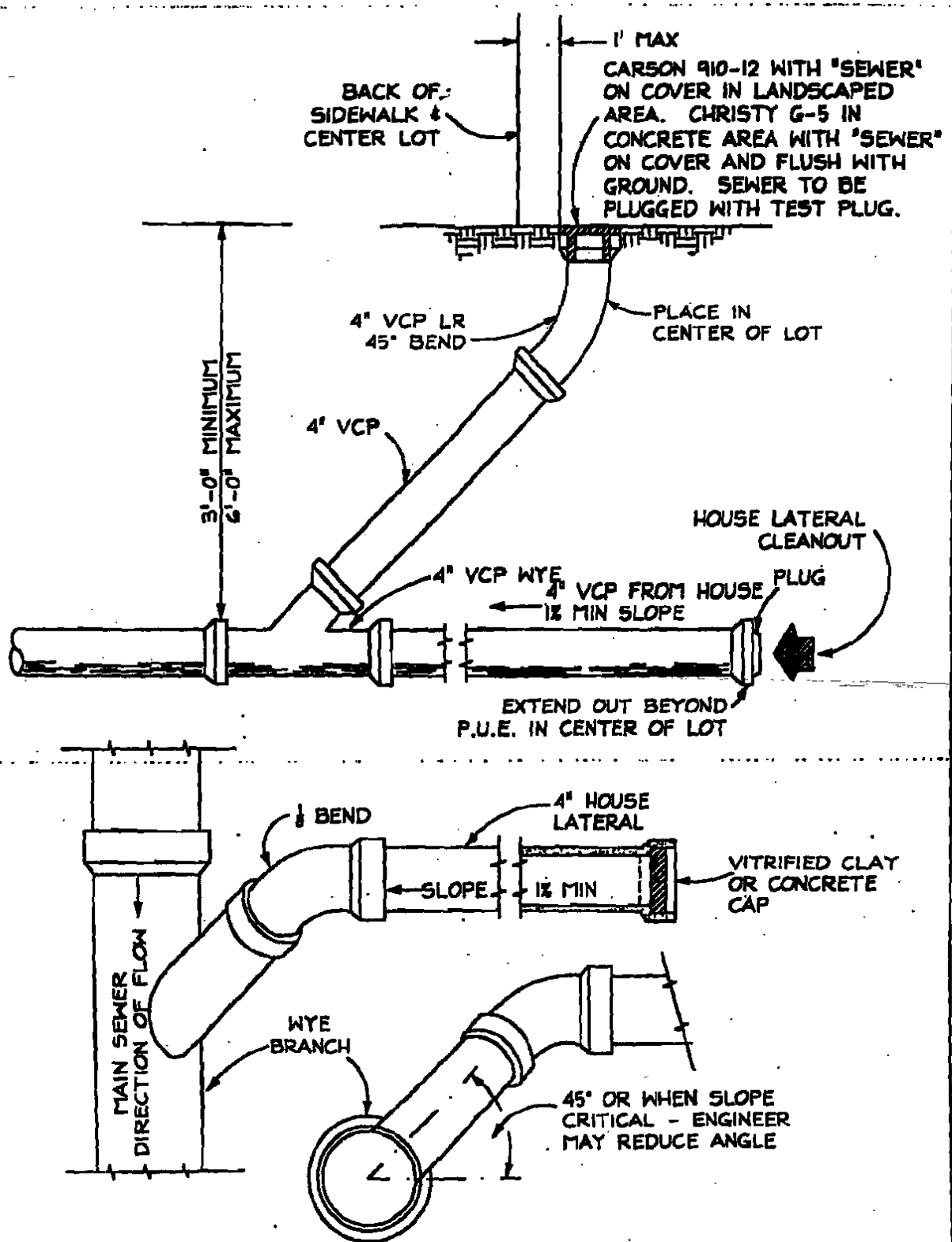

Sewer Service Clean out Detail
ESPARTO COMMUNITY SERVICES DISTRICT

DETAIL # 10 AND # 11

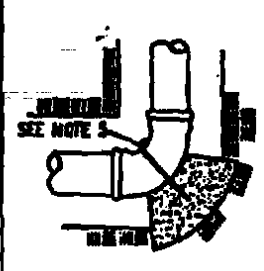
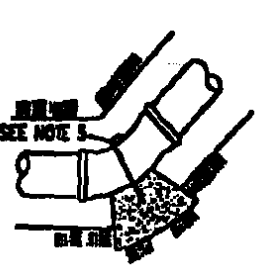
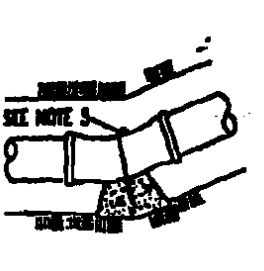
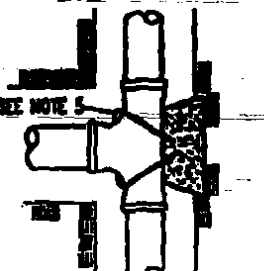
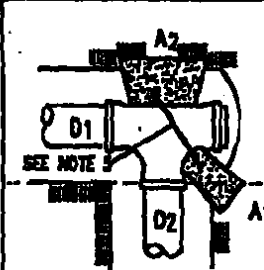
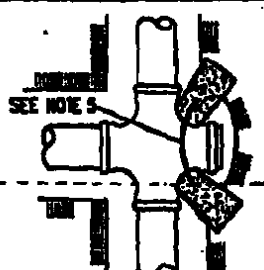
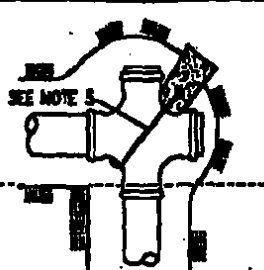
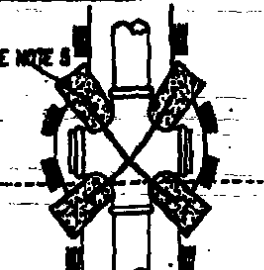
TYPE OF FITTING	90° BEND	45° BEND	11 1/2" OR 22 1/2" BEND	TEE OR DEAD END	
TYPICAL INSTALLATION					
SIZE OF PIPE	4"	2	1	2	
	6"	4	2	3	
	8"	7	4	5	
	10"	12	6	8	
	12"	16	10	12	
	24"	60	30	16	
	30"	90	45	25	
TYPE OF FITTING	TEE WITH PLUG	CROSS WITH PLUG	CROSS WITH PLUGS	CROSS WITH PLUGS	
TYPICAL INSTALLATION					
SIZE OF PIPE	4"	4" 2	4" 2	2	2
	6"	6" 4	6" 3	4	4
	8"	8" 6	8" 5	7	7
	10"	10" 10	10" 8	12	12
	12"	12" 14	12" 12	16	16
	24"	24" 55	24" 40	40	40
	30"	30" 80	30" 60	60	60

REQUIRED BEARING ~ TOTAL SQUARE FEET

NOTES:

1. THRUST BLOCKS TO BE CONSTRUCTED OF CLASS "B" CONCRETE.
2. AREAS GIVEN ARE FOR CLASS 150 PIPE AT TEST PRESSURE OF 150 P.S.I. IN SOIL WITH 2,500 P.S.F. BEARING CAPACITY. INSTALLATIONS USING DIFFERENT PIPE, TEST PRESSURES, AND/OR SOIL TYPES SHOULD ADJUST AREAS ACCORDINGLY, SUBJECT TO APPROVAL BY CITY ENGINEER.
3. THRUST BLOCKS TO BE POURED AGAINST UNDISTURBED SOIL.
4. JOINTS TO BE KEPT CLEAR OF CONCRETE.
5. NUMBER 4 REBAR SHALL BE PLACED OVER PIPE AND EMBEDDED IN CONCRETE WHEN PIPE DIA. IS 10" OR LESS.
6. THRUST BLOCKS TO BE IN PLACE 7 (SEVEN) DAYS BEFORE TESTING.
7. ALL PLUGS SHALL BE SECURED WITH THRUST BLOCKS.
8. RETAINER GLANDS (BAA IRON, SERIES 100 OR EQUAL) MAY BE USED WITH JOINT FITTINGS IN LIEU OF THRUST BLOCKS WHERE THRUST BLOCKS ARE NOT FEASIBLE.

Thrust Blocks

ESPARTO COMMUNITY SERVICES DISTRICT

DETAIL # 13

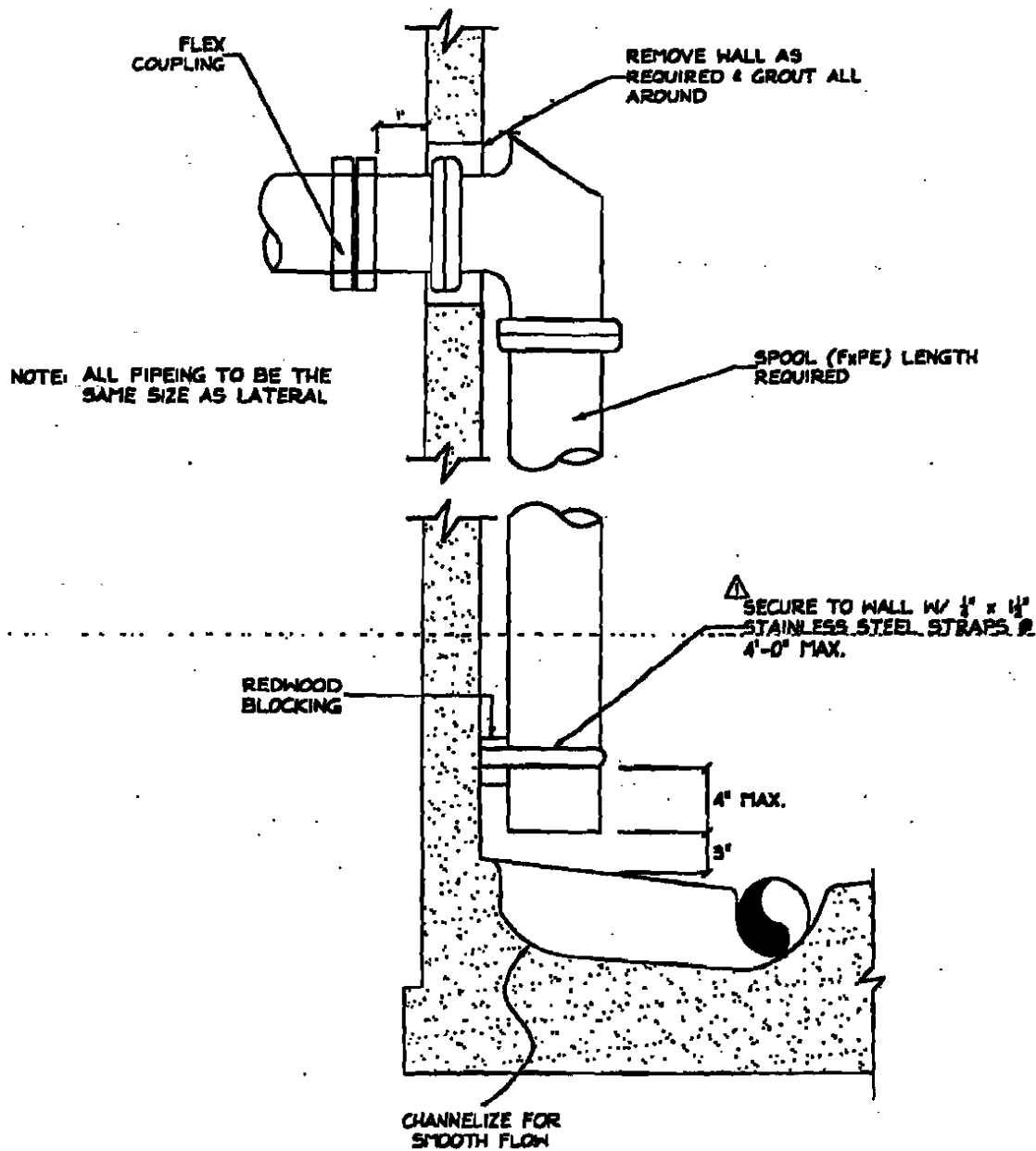

Manhole Drop Connection
ESPARTO COMMUNITY SERVICES DISTRICT

DETAIL # 14

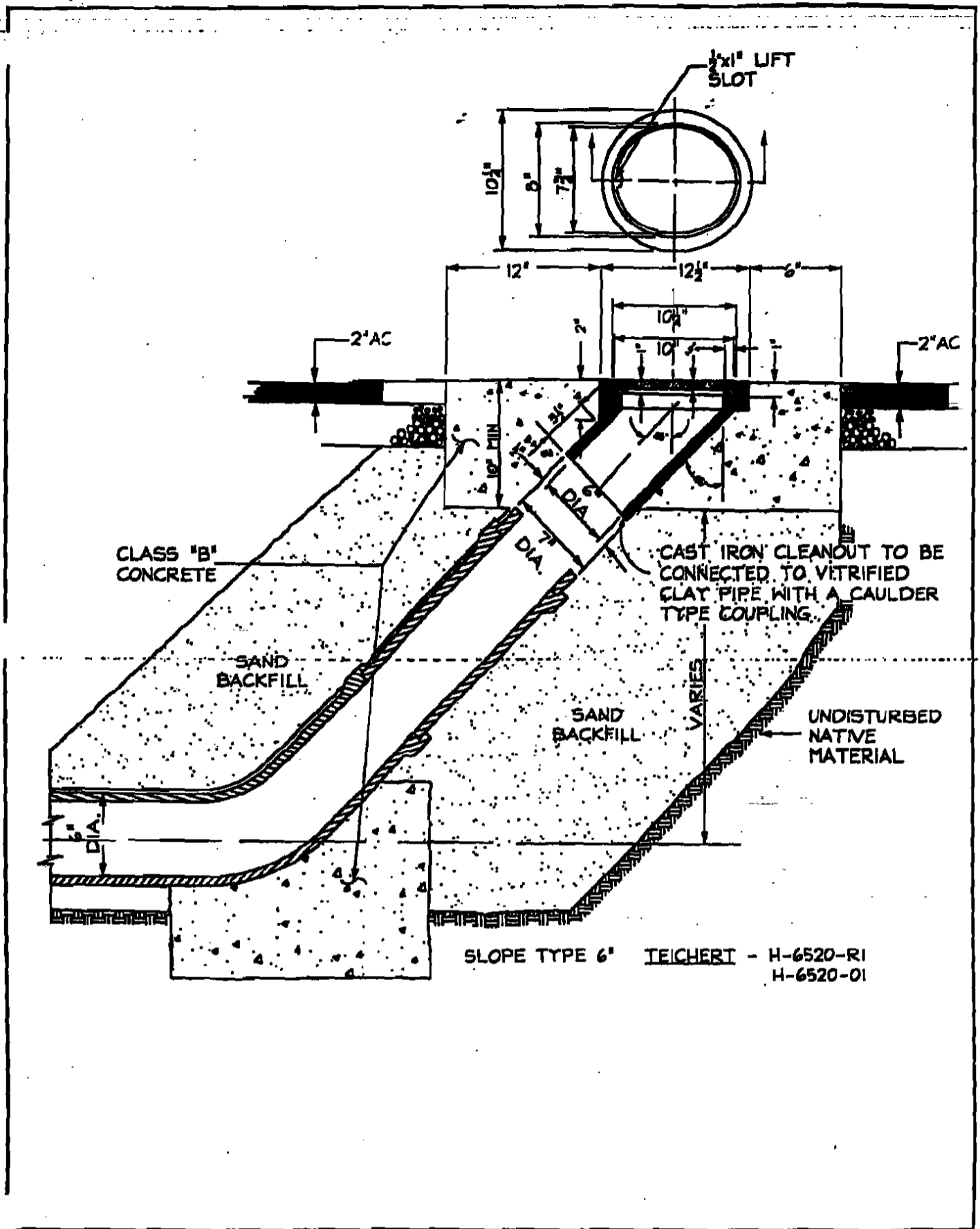

Clean out Assembly
ESPARTO COMMUNITY SERVICES DISTRICT

DETAIL 84E

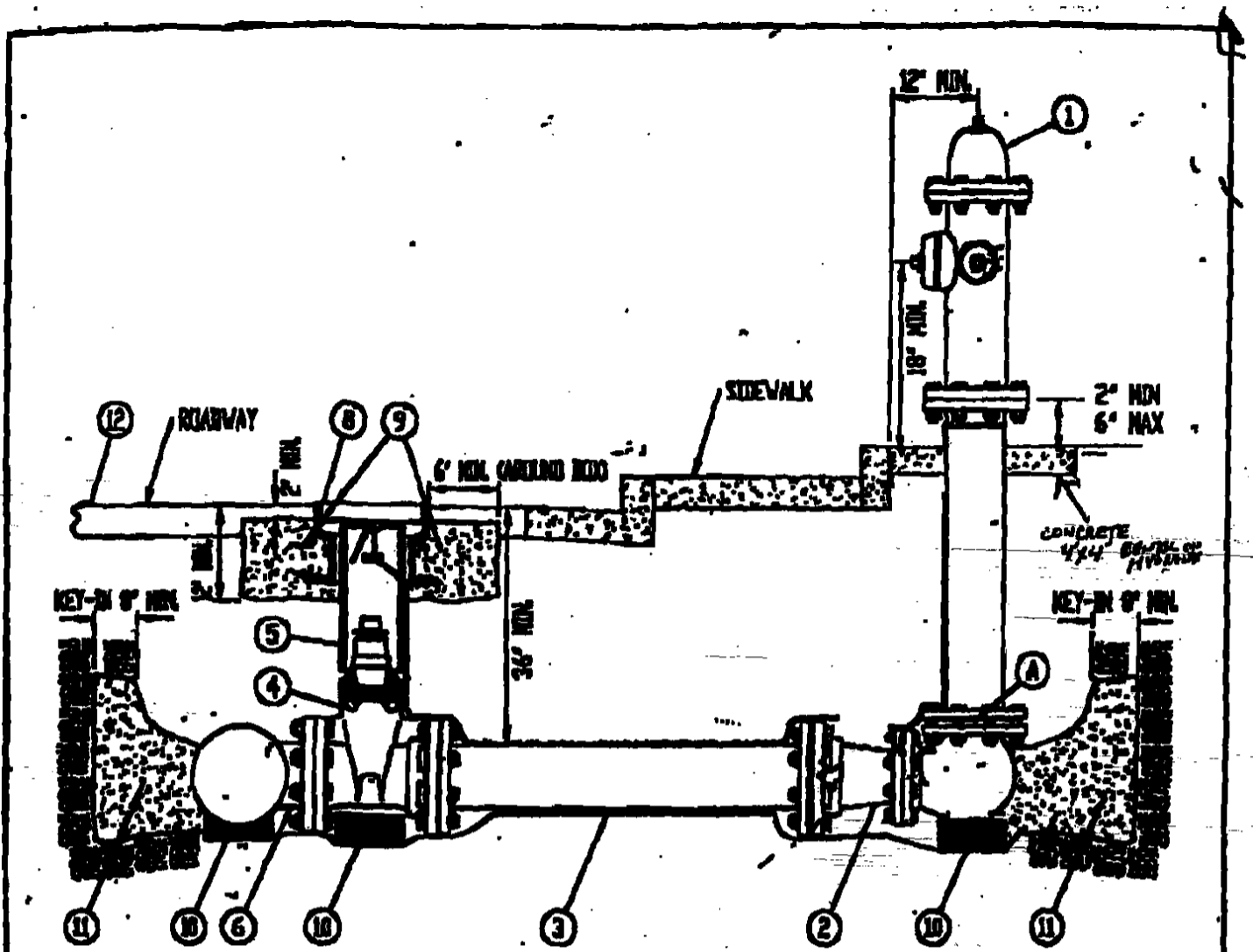

NOTES
 A. GALVANIZED PLUGS SHALL BE INSTALLED IN DRAIN HOLES IN SIDE.

1	STEAMER FIRE HYDRANT - MINIMUM 48" BURY - PAINT RUSTLEUM WHITE - FLANGED BURY	8	VALVE BOX - CHRISTY 6-5
2	8" MECHANICAL JOINT x 6" FLANGED REDUCER	9	CONCRETE PAD AROUND VALVE BOX
3	8" DUCTILE IRON PIPE	10	CONCRETE BLOCK - 3' x 5' x 7 1/2"
4	8" GATE VALVE - RESILIENT SEAT - FLANGED TO TEE x MECHANICAL JOINT	11	CONCRETE THRUST BLOCK - 4 Sq. Ft. MIN. BEARING AREA
5	8" RISER - SDR35 PVC ONLY	12	BLUE REFLECTIVE MARKER - INSTALLED PER SACRAMENTO METROPOLITAN FIRE PROTECTION DISTRICT SPECIFICATIONS
6	TEE - DUCTILE IRON - FLANGED OUTLET		

Fire Hydrant Normal Installation
ESPARTO COMMUNITY SERVICES DISTRICT
DETAIL # 16

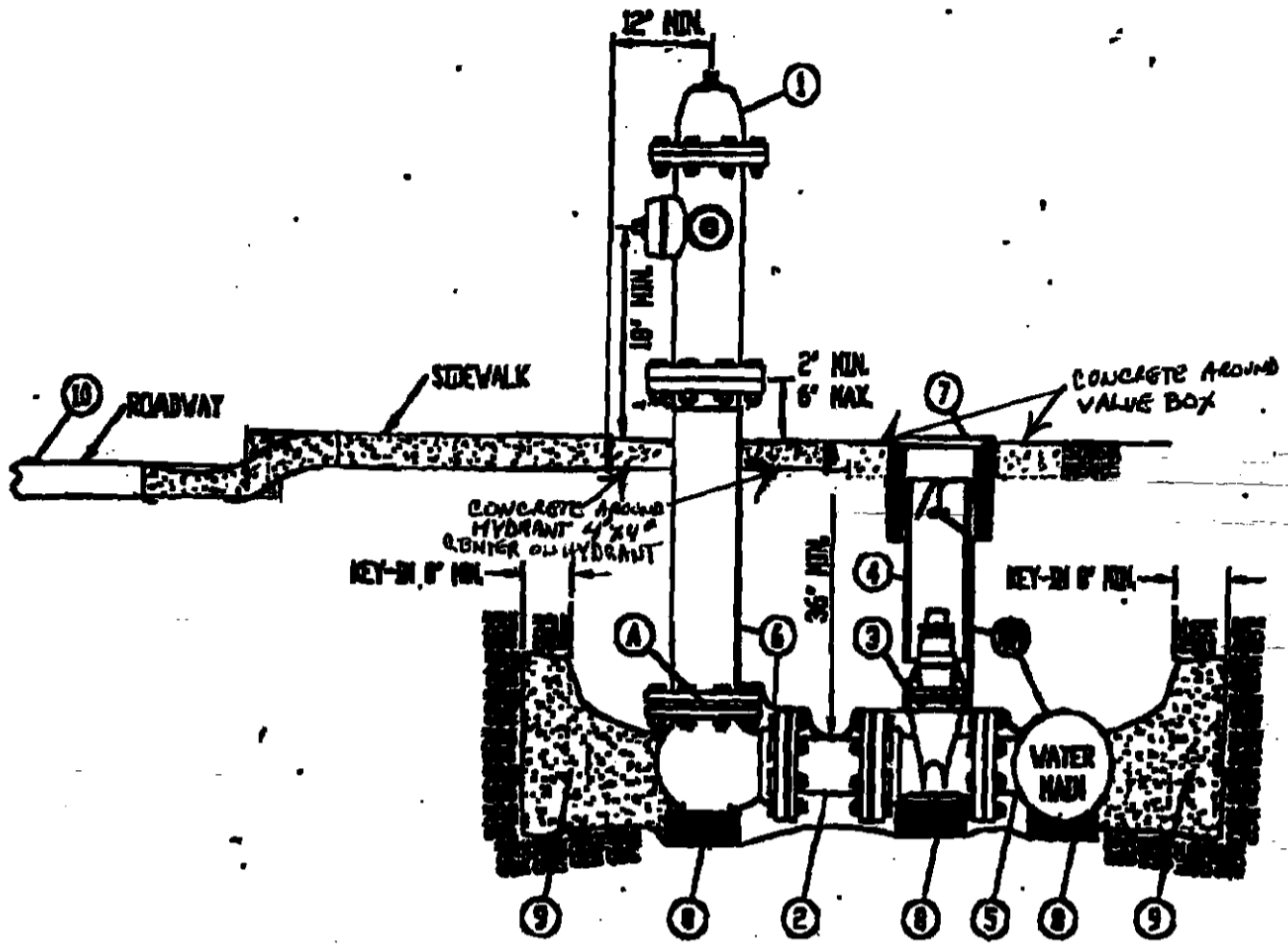

NOTES:
 A. GALVANIZED PLUGS SHALL BE INSTALLED IN DRAIN HOLES IN STEEL.

1	STEAMER FIRE HYDRANT - MINIMUM 40" BURY - PAINT RUSTLEUM WHITE - MECHANICAL JOINT OR RING TIGHT	5	TEE - DUCTILE IRON - FLANGED OUTLET
2	6" PIPE PIP - 12" NOM LENGTH	6	
3	6" GATE VALVE - RESILIENT SEAT - FLANGED TO TEE x MECHANICAL JOINT	7	VALVE BOX - CHRISTY G-5
4	6" RISER - SD35 PVC OR RIGID PIPE	8	CONCRETE BLOCK - 3' x 5' x 7 1/2"
		9	CONCRETE THRUST BLOCK - 4 SQ. FT. NOM BEARING AREA
		10	BLUE REFLECTIVE MARKER - INSTALLED PER SACRAMENTO METROPOLITAN FIRE PROTECTION DISTRICT SPECIFICATIONS

**Fire Hydrant Short Side Installation
 ESPARTO COMMUNITY SERVICES DISTRICT**

DETAIL # 17

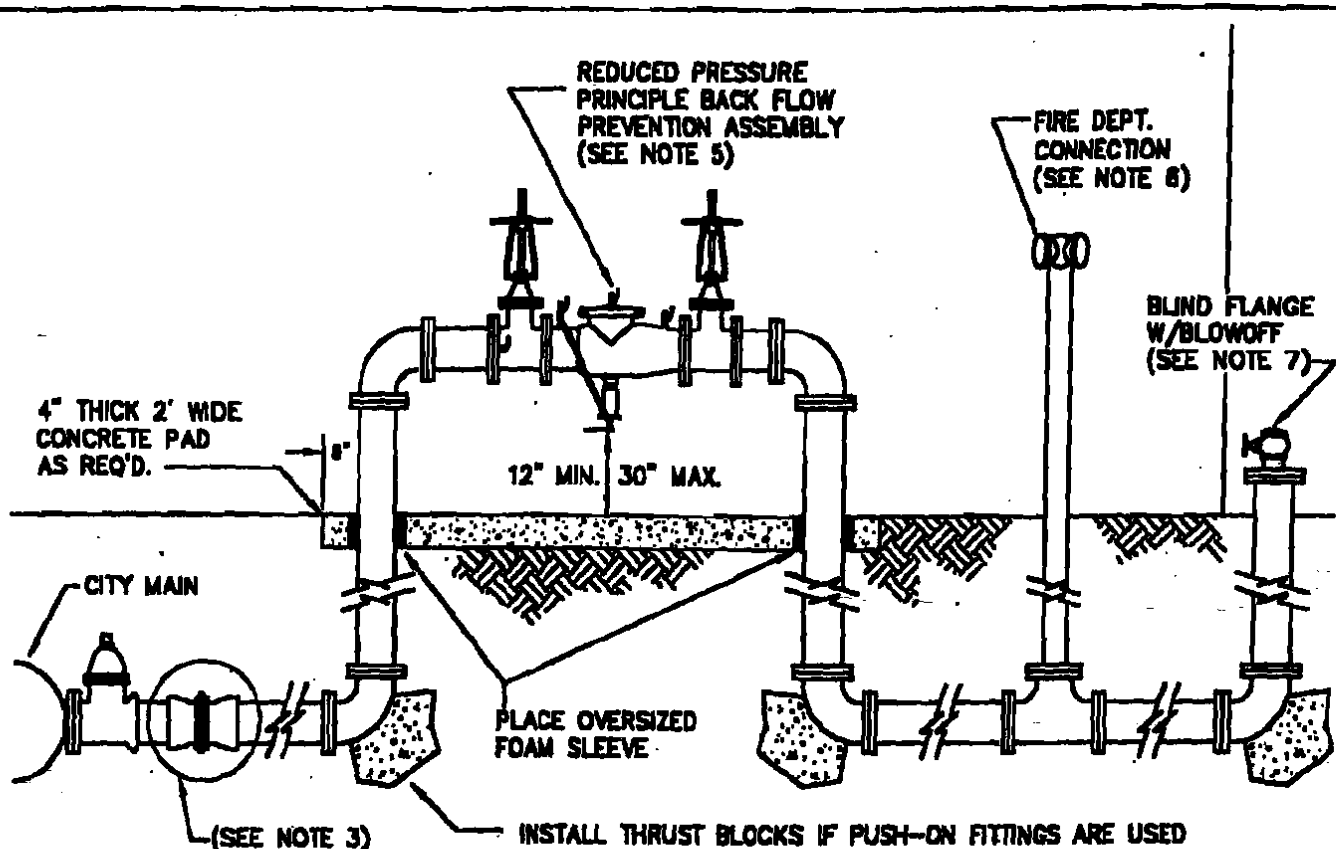

- (SEE NOTE 3) INSTALL THRUST BLOCKS IF PUSH-ON FITTINGS ARE USED
1. A CLASS 'A' CONTRACTOR'S LICENSE IS REQUIRED FOR WORK IN THE CITY RIGHT OF WAY.
 2. INSTALLATION OF THE FIRE SERVICE CONNECTION SHALL BE IN ACCORDANCE WITH AWWA C600-87.
 3. INSTALL TEST PLATE AND JUMPER ASSEMBLY IN ACCORDANCE WITH STANDARD CITY DETAIL No. 17. [△]
 4. PIPES AND FITTINGS SHALL BE DUCTILE IRON CL250 MINIMUM.
 5. IF POSSIBLE, PLACE REDUCED PRESSURE DEVICE 6' BEHIND BACK OF S/W. APPROVED BACK FLOW PREVENTION ASSEMBLIES: AMES, FEBCO OR APPROVED EQUAL CERTIFICATION BY AN AWWA LICENSED TESTER SHALL BE DELIVERED TO PUBLIC WORKS, WATER/SEWER DIVISION UPON INSTALLATION AND ANNUALLY THEREAFTER ACCORDING TO CITY OF COLUSA BACKFLOW ADMINISTRATOR. [△]
 6. FIRE SERVICE CONNECTION SHALL BE INSTALLED 18" FROM BACK OF S/W, 30' MIN./50' MAX. FROM A FIRE HYDRANT.
 7. PROVIDE TEMPORARY BLIND FLANGE W/ BLOWOFF AT BUILDING. AFTER TESTING THE FIRE SERVICE FROM THE MAIN TO THE BUILDING, REMOVE FLANGE AND MAKE CONNECTION.
 8. DISINFECTING OF THE FIRE SERVICE SHALL BE IN ACCORDANCE WITH AWWA C651-98.
 9. TESTING THE FIRE SERVICE CONNECTION FROM THE WATER MAIN TO THE BACKFLOW ASSEMBLY SHALL BE COORDINATED WITH PUBLIC WORKS, WATER/SEWER DIVISION. TESTING FROM THE BACKFLOW ASSEMBLY TO THE BUILDING SHALL BE COORDINATED WITH THE FIRE DEPARTMENT. [△]
 10. TESTING BY PUBLIC WORKS, WATER/SEWER DIVISION SHALL CONSIST OF A 2 HOUR PRESSURE TEST @ 200 PSI AND BACTERIA TEST AFTER THE FIRE SERVICE HAS BEEN SUFFICIENTLY FLUSHED. [△]
 11. IF THE FIRE SERVICE CONNECTION SERVES MORE THAN ONE BUILDING, A POST INDICATOR VALVE IS REQUIRED FOR EACH BUILDING.
 12. [△] PAINT THE CURB 15' ON EACH SIDE OF THE FIRE HYDRANT.

Large Fire Service Connection ESPARTO COMMUNITY SERVICES DISTRICT

DETAIL # 18

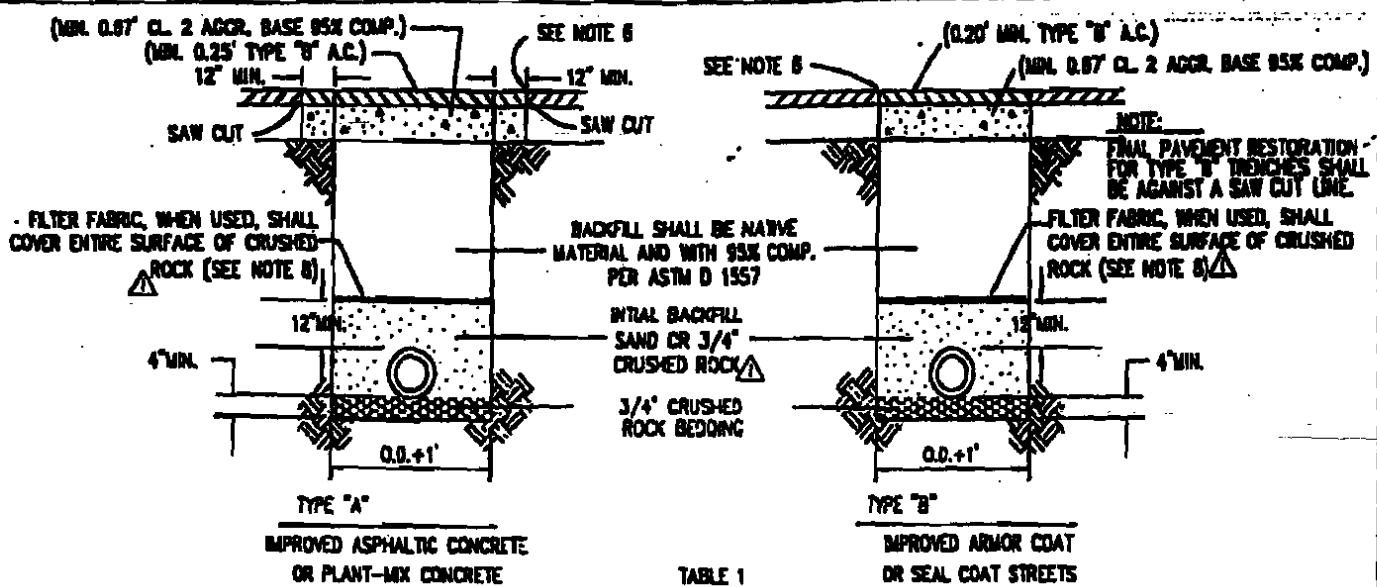
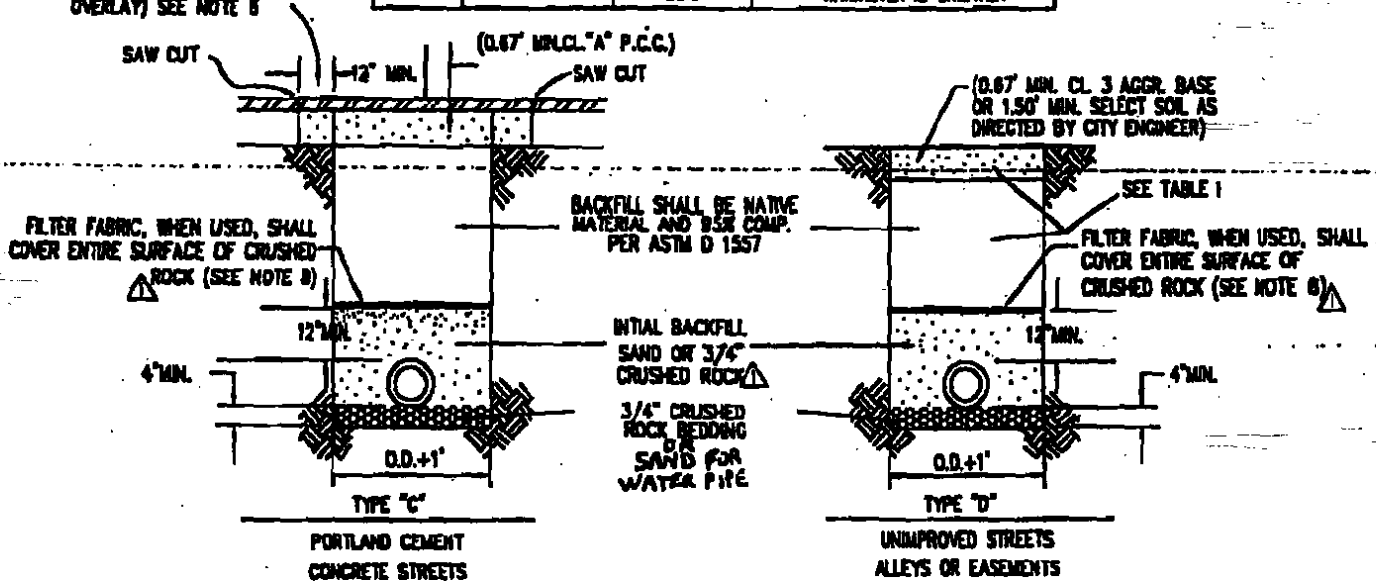

TABLE 1

TYPE	LOCATION	BACKFILL & COMP.	RESTORATION TYPE
D-1	WITHIN 3' E.P.	STRUCTURE 95%	6" CL. 3 A.R.
D-2	GREATER THAN 3' TO E.P.	SELECT SOIL 90%	1.5' MIN. SELECT SOIL
D-(SW)	SIDEWALK AREAS	STRUCTURE 95%	4" P.C.C. OR EQUAL TO EXIST. WHICHEVER IS GREATER

(PLACE TYPE "B" A.C. IF PAVEMENT HAS AN A.C. OVERLAY) SEE NOTE 6



NOTES:

1. TYPE "A" & "C" TRENCHES REQUIRE (2) TWO CUTS; FIRST CUT INITIAL TRENCH WIDTH, THEN 30 DAYS AFTER WORK HAS BEEN COMPLETED IT SHALL BE SAW CUT A MINIMUM OF 12" WIDER BOTH SIDES.
 2. TYPE "A" & "C" TRENCHES REQUIRE PLACEMENT AND MAINTENANCE OF TEMPORARY PAVEMENT (SC-800 COLD MIX), COMPACTED IN PLACE USING A VIBRATING ROLLER OR VIBROPLATE, FOR A MINIMUM OF 30 DAYS PRIOR TO PERMANENT PAVING.
 3. STRUCTURAL THICKNESS SHOWN ARE MINIMUM ALLOWABLE. OVER THICKNESS OF STRUCTURAL SECTIONS MAY BE REQUIRED BY CITY ENGINEER IF EXISTING STRUCTURAL SECTION EXCEEDS THESE MINIMUMS.
 4. ALL TRENCH WORK 5' AND DEEPER SHALL HAVE APPROVED SHORING, ALL IN ACCORDANCE WITH STATE LAW.
 5. NATIVE MATERIAL MUST BE SUITABLE TO OBTAIN THE 95% COMPACTION REQUIRED.
 6. PAVING SURFACE AT TRENCH JOINTS SHALL BE SEALED WITH ASPHALT EMULSION AT EACH JOINT AFTER FINAL COMPACTION OF ASPHALT CONCRETE. SEALANT SHALL BE SANDED AS NECESSARY TO PREVENT TRAFFIC PICKUP.
 7. IF S.E. \geq 20, NATIVE MATERIAL MAY BE JETTED. IF S.E. $<$ 20, NATIVE MATERIAL SHALL BE INSTALLED USING A MECHANICAL METHOD OF COMPACTION AND A GEOTECHNICAL FIRM, APPROVED BY THE ENGINEER, SHALL SUPERVISE THE INSTALLATION AND PERFORM ALL REQUIRED TESTING. SEE SPECIFICATIONS FOR FREQUENCY OF ASTM D 1557 TEST AND SPECIAL TRENCH WARRANTY REQUIREMENTS.
- ▲ IF CRUSHED ROCK IS USED FOR INITIAL BACKFILL, FILTER FABRIC SHALL BE LAYED BEFORE COMPLETING BACKFILL.

Bedding, Backfill and Trench Restoration
ESPARTO COMMUNITY SERVICES DISTRICT

DETAIL # 19